

LAYOUT INSPECTION

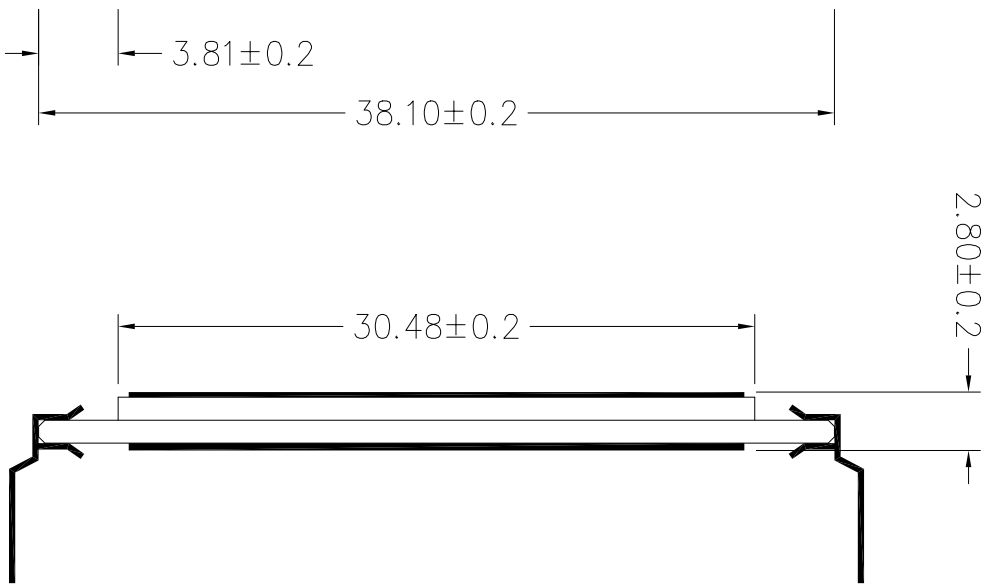
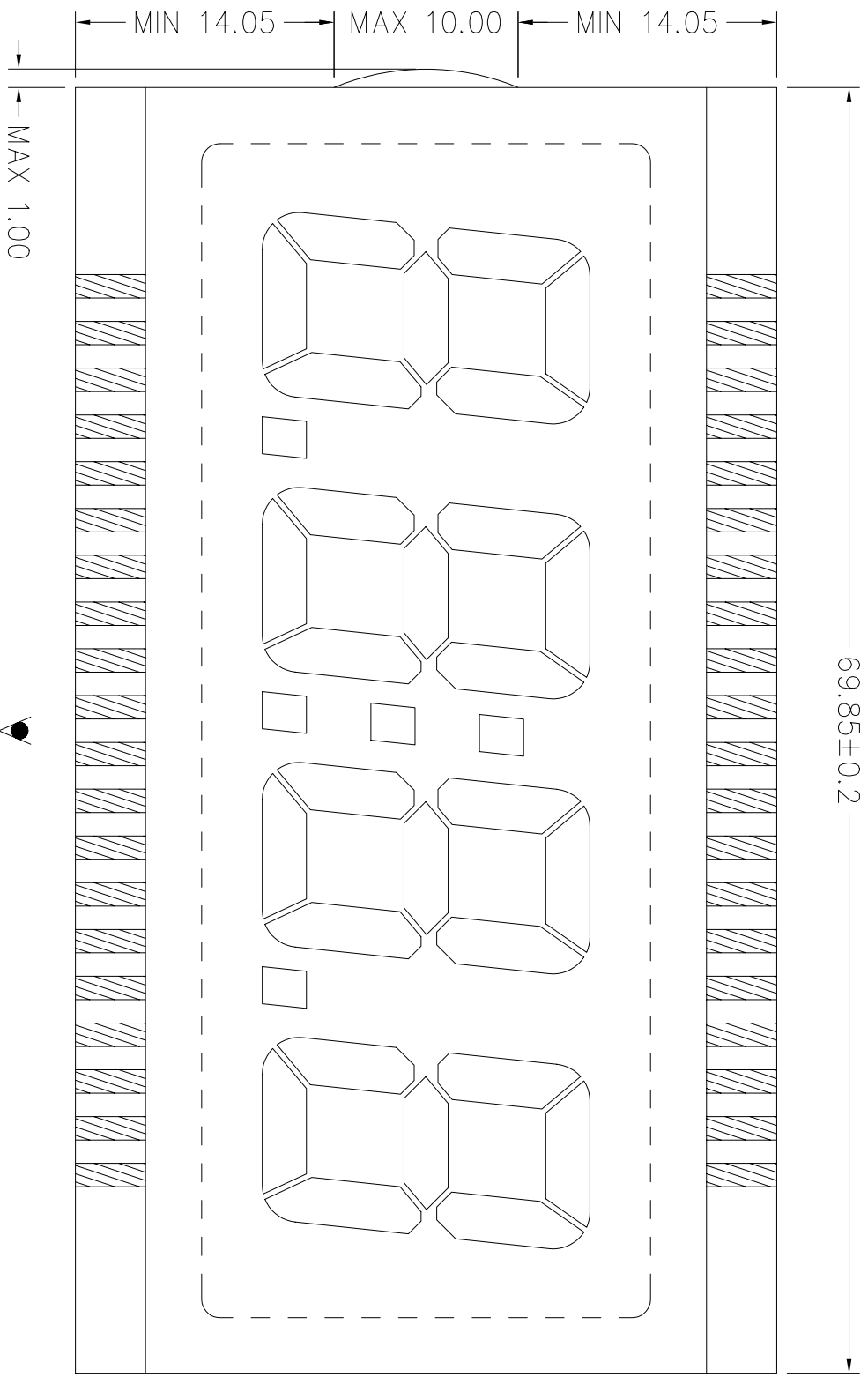

6

REMARKS: "◇" SPECIAL CHARACTERISTIC
 " + " SAFETY CHARACTERISTIC
 " () " REFERENCE ONLY

DWGNO : VI-415-1		REV : 10	
VARITRONIX LTD.		Dimension : mm	TOL : ±0.2 IF NOT SPECIFY
Drawn by : QMZ	SIGN :	DD NOT SCALE DRAWING	Date : 2004-11-29
Checked by : MAKD	SIGN :	Date :	3 rd ANGLE PROJECTION

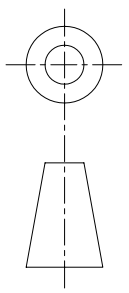

DWG.NO.: VI-415-1 (REV.0)

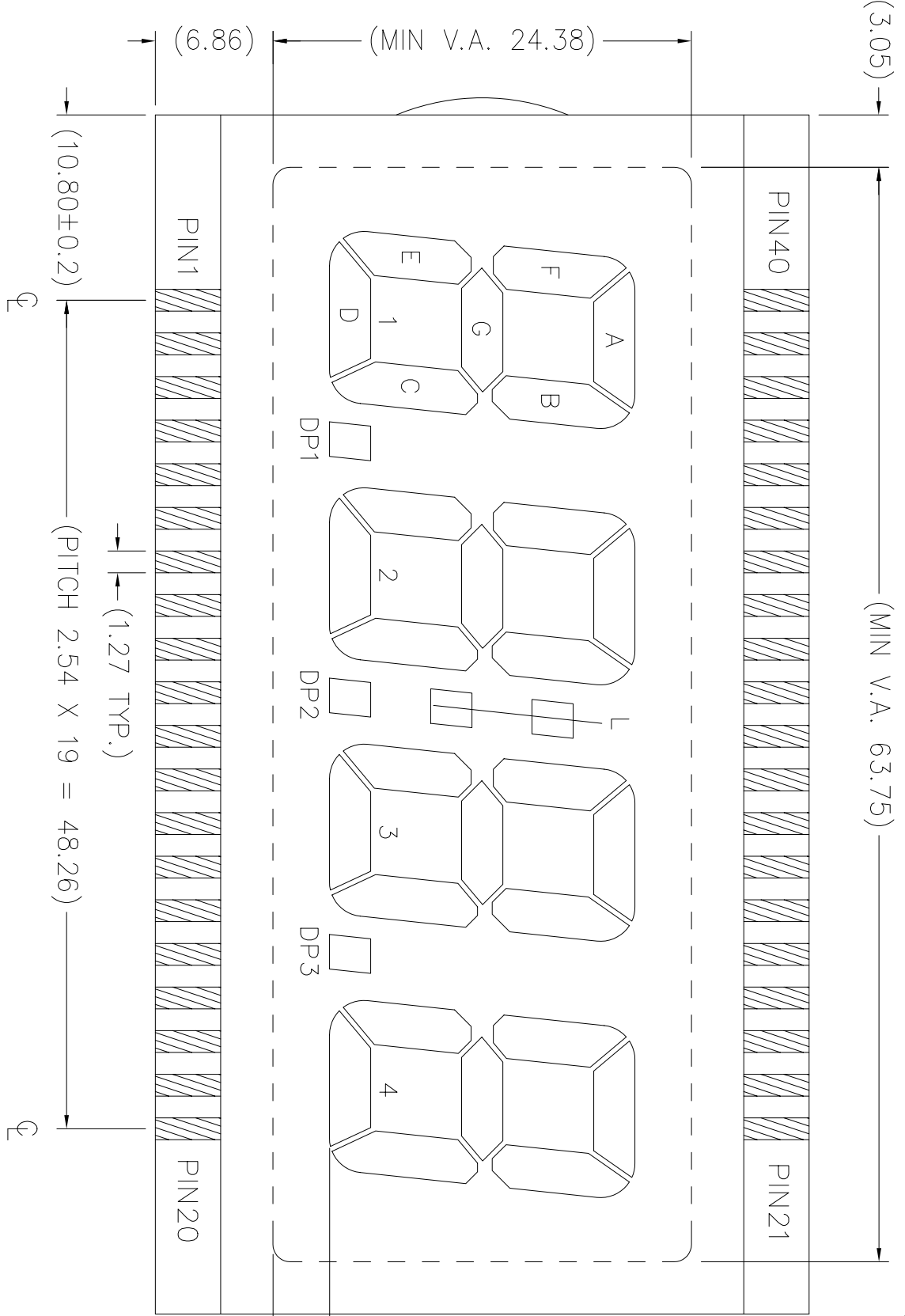

(BEVEL EDGE(4X))

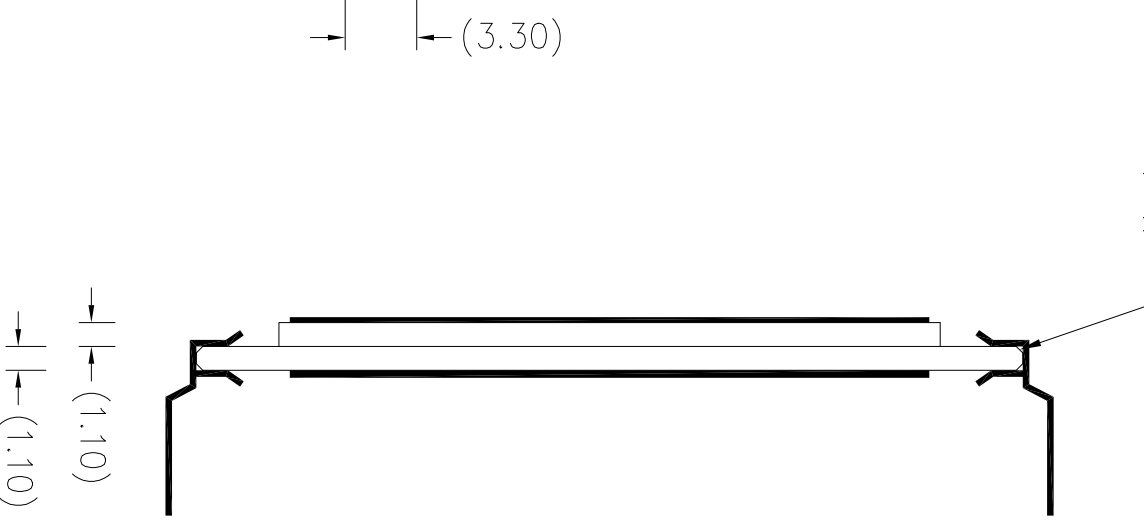

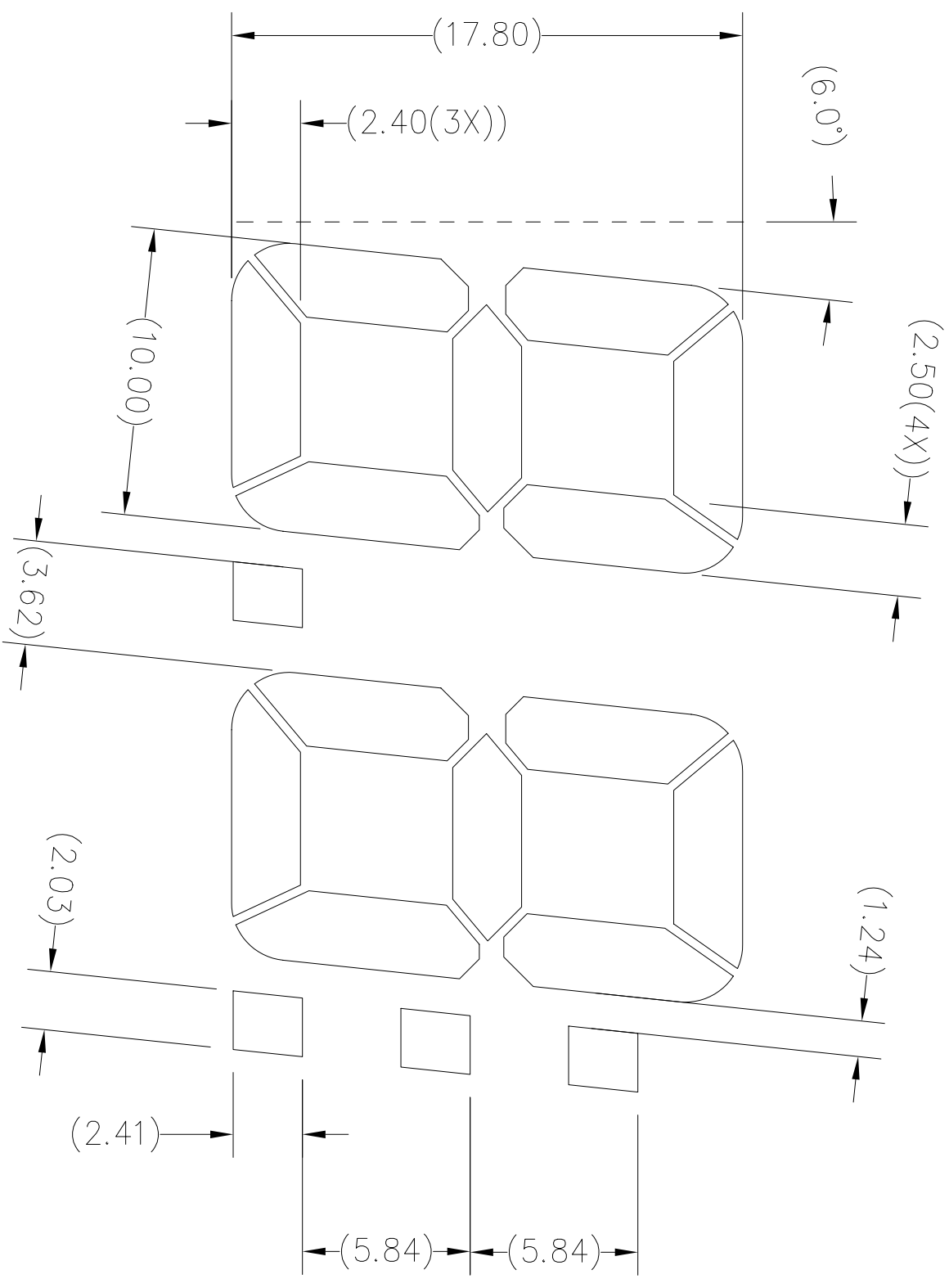

DWG.NO.: VI-415-1 (REV.0)

SEGMENT TRACKING

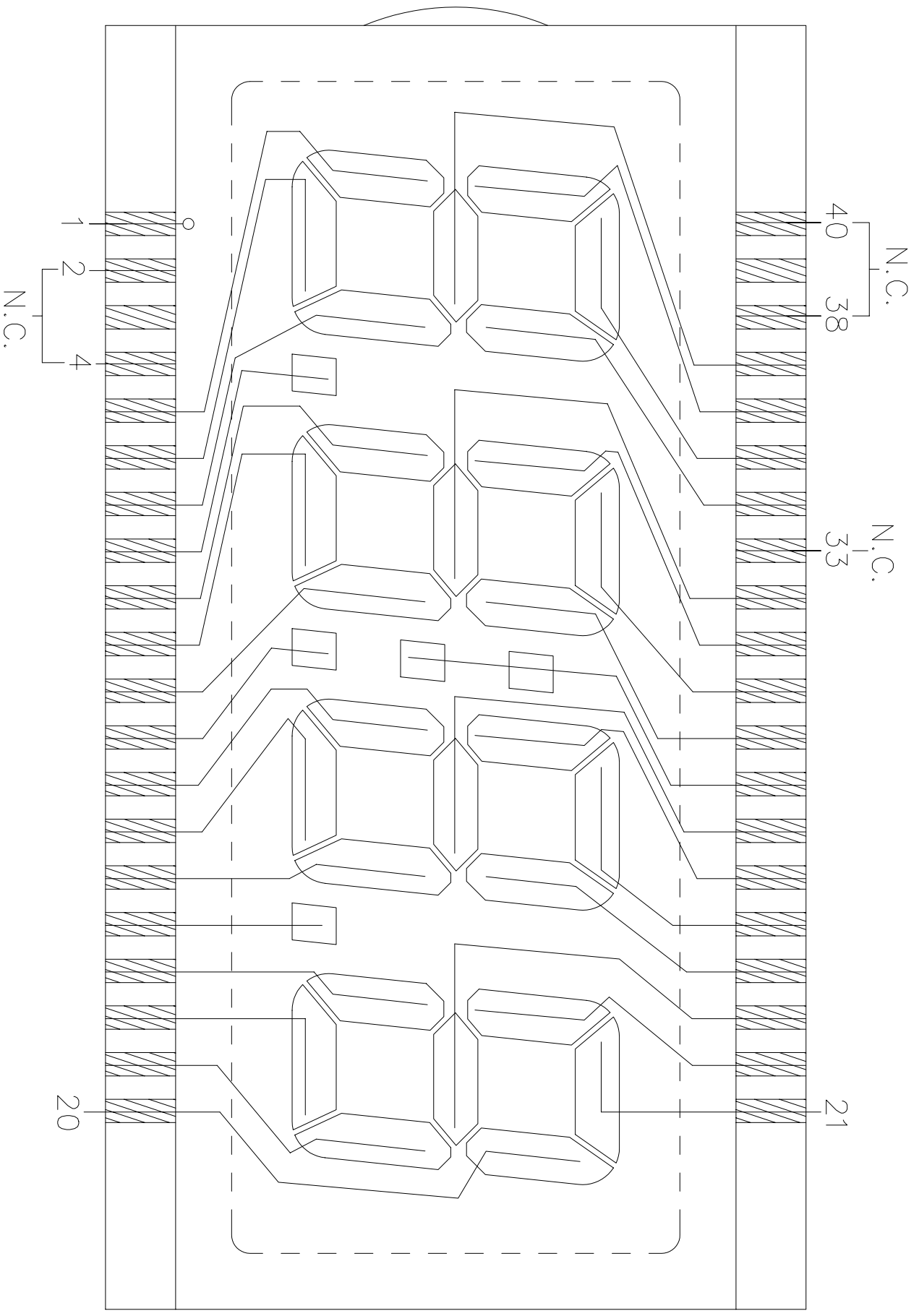

REMARKS: N.C. = NO CONNECTION

DWG.NO.: VI-415-1 (REV.0)

COMMON TRACKING

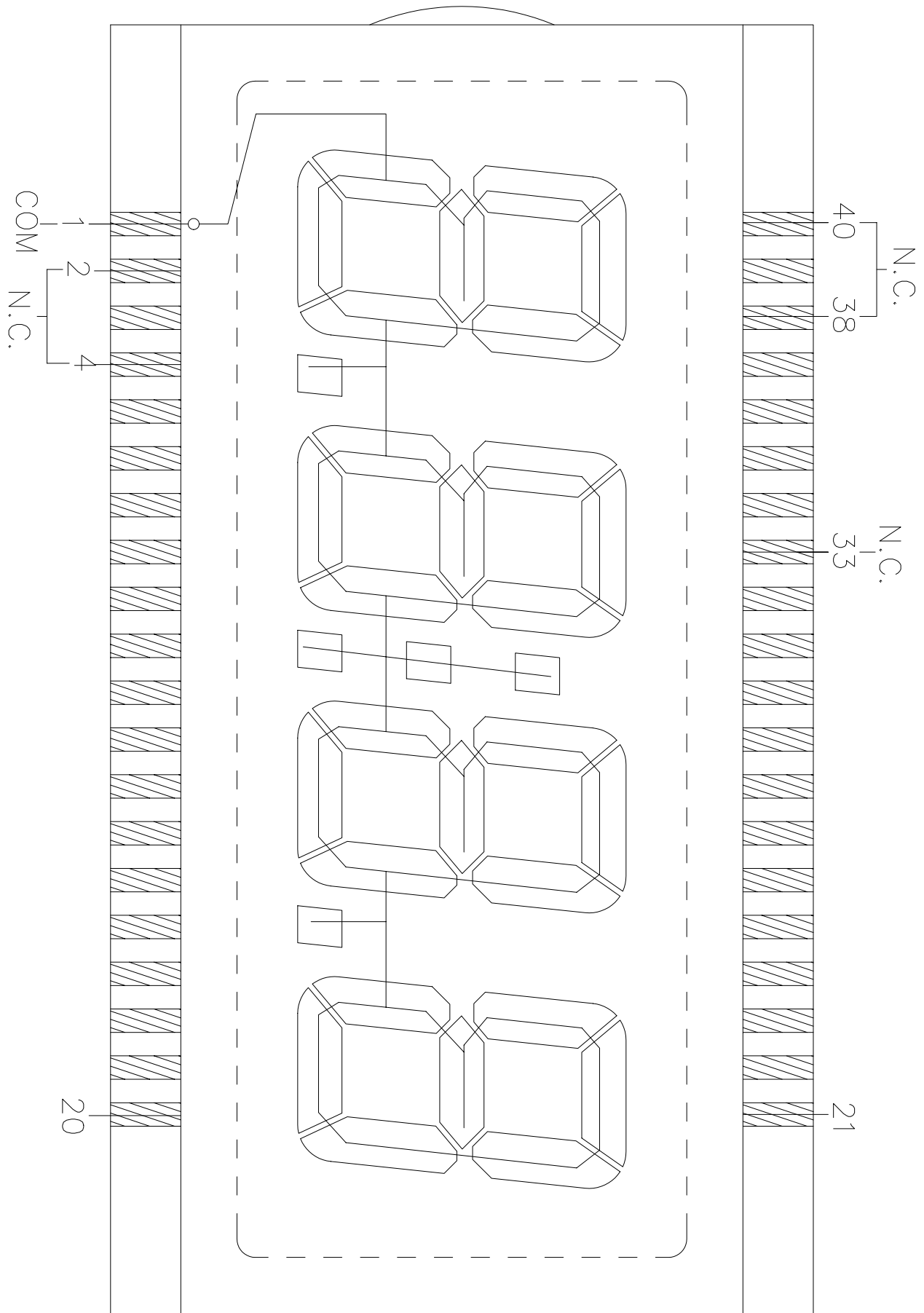

REMARKS : N.C. = NO CONNECTION

VARTRONIX LIMITED		OPEN LAYER :	SCALE
POLARIZER LOCATION DIAGRAM		P	Do not scale
DOC. NO. : PL-VI-415-1-01		Drawn by : QM/Z	Date : 2004-11-29
		Checked by : INA	Date :
		Approval by :	Date :

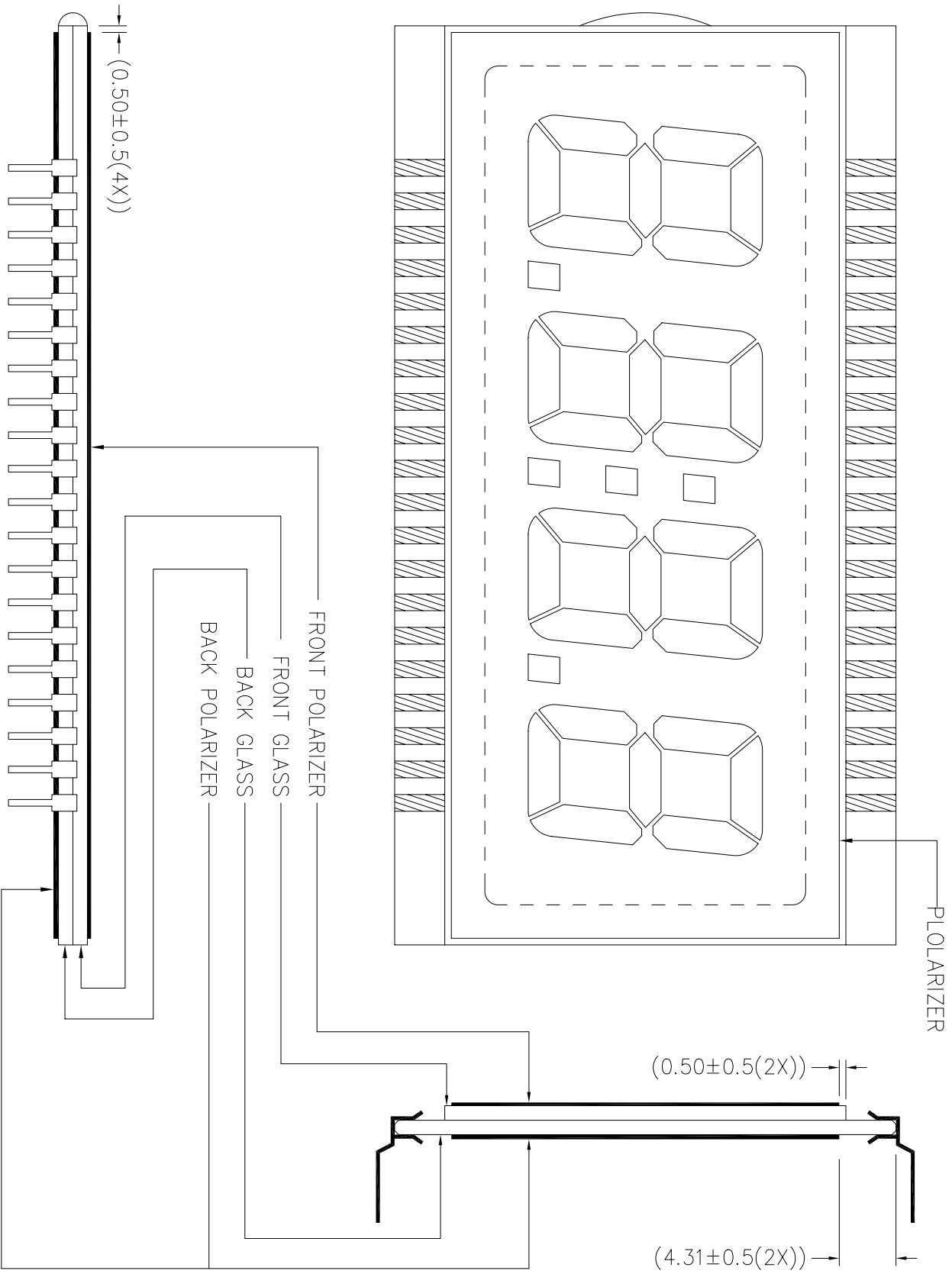

VARITRONIX LIMITED		OPEN LAYER :	SCALE
DIL-PIN DETAILS LOCATION DIAGRAM		DP-L0	Do not scale
DOC. NO. : DP-VI-415-1-01	Drawn by : QMZ	Checked by : INA	Date : 2004-11-29
ALL DIMENSIONS IN mm	Approval by :	Date :	

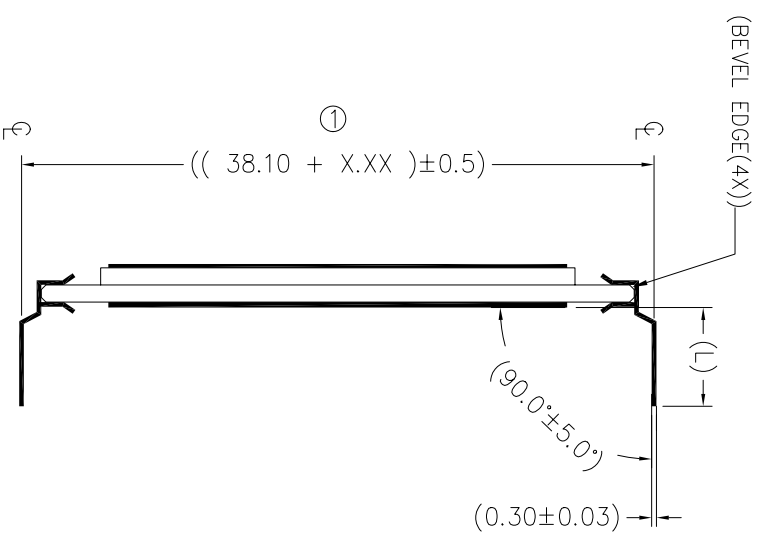
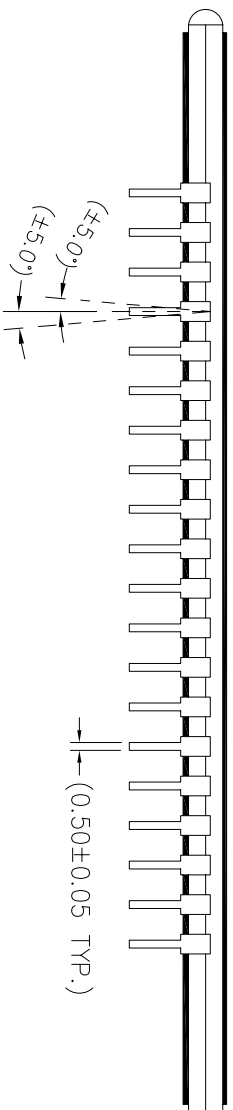
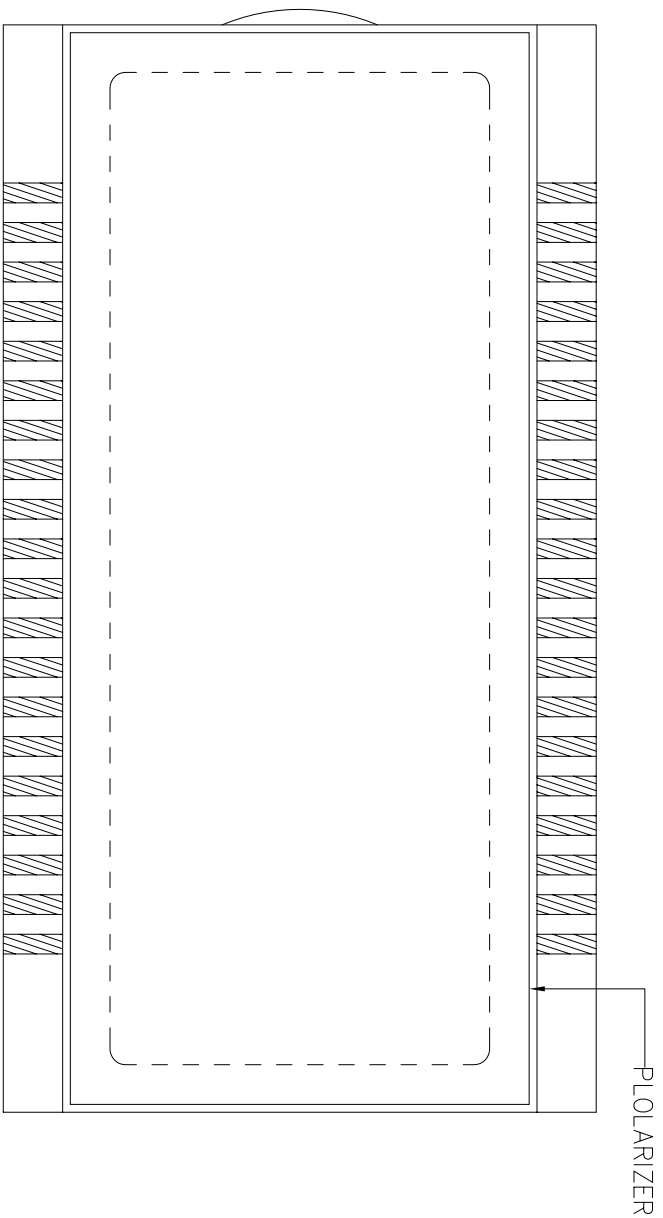

REMARKS: ① ----- X.XX=2.54 (FOR PIN LENGTH \geq 3.20 & \leq 10.00mm)
X.XX=1.75 (FOR PIN LENGTH $>$ 10.00 & \leq 19.50mm)
PIN LENGTH (L) REFER TO COVER PAGE

DWG.NO.: VI-415-1 (REV.0)

PIN	COM	PIN	COM	PIN	COM	PIN	COM
1	COM	11	2C	21	4A	31	2F
2	N.C.	12	DP2	22	4F	32	2G
3	N.C.	13	3E	23	4G	33	N.C.
4	N.C.	14	3D	24	3B	34	1B
5	1E	15	3C	25	3A	35	1A
6	1D	16	DP3	26	3F	36	1F
7	1C	17	4E	27	3G	37	1G
8	DP1	18	4D	28	L	38	N.C.
9	2E	19	4C	29	2B	39	N.C.
10	2D	20	4B	30	2A	40	N.C.

REMARKS: N.C. = NO CONNECTION